



# **SUITA S1** Power Analyzer



- Max Measuring Accuracy:  $\pm (0.1\% \text{ of reading} + 0.05\% \text{ of range})$
- Bandwidth: DC, from 0.1Hz to 100kHz
- Voltage, current wide-range: Direct input (from 6 to 600V; from 5mA to 20A; from 1 to 50A)
- Up to 100 harmonic orders

SUITA ELECTRIC Corporation, founded in Suita, Osaka, Japan, is a company specializing in high-end equipment. Rooted in the technological achievements after years of research and development, the top-notch products of our company, with good quality, apply in many industries such as electric power, energy resource, transportation, automobile, telecommunication, and our advanced, reliable, and comprehensive solutions of test and measurement are provided to many R&D companies and manufacturers, systematic approaches meeting the deep demands of our customers to support the development and continuous update of the global industries.

Power analyzer of S1 series is a powerful instrument for measuring home appliances, OA products (office automation), electrical equipment and devices of process control automation.

It is widely used in the areas such as power industry, office or home appliances testing and evaluation, battery drive test and motor efficiency test. This instrument is also equipped with the functions such as recording real time waveform and the waveform data and analyzing the harmonic.



# Functions and Advantages

## Wide-range for Current Measurement

Either large current or low current, ranging from micro-ampere to several tens of amperes can be measured, as well as the current changing greatly in the conditions such as stand-by, booting the power analyzer and normal working. One piece of this device with module required can perform the measurement.

## Simultaneously Measuring all Parameters

The power analyzer of this series can measure all DC and AC parameters. It can also measure harmonics and perform integration simultaneously without changing the measurement mode.

## Fast Display and Data Update Rate

The fast display and 50ms maximum data update rate of the power analyzer can offer users a shorter test time in their testing procedures.

## Peak Hold Function

The maximum values of RMS/MEAN/DC/PEAK, voltage & current, active power, reactive power and apparent power can be held.

## Configuration Parameters Saving and Loading

This instrument can save the configuration parameters which can be fast loaded when in similar measurement conditions next time, reducing the time spent by users for parameter access next time.

## D/A Output for Measurement Recording

The D/A option can be used to output the Voltage, Current, Power and other measured data and record them in the data loggers or other devices ( $\pm 5\text{VDC}$  outputs).

## Current Sensor Input

The instrument with expanded range of current measurement is equipped with current clamps or current sensors of voltage output model.

## Computation Function

Multiple computations are available on this instrument, including performing computations such as efficiency, crest factor, four arithmetic operations and average active power.

## Data Storage

The measured data can be stored, and internal free memory space is available up to 4G. And the stored data can be accessed to and analyzed via computer or PC connected instead of being displayed and loaded in the screen of this power analyzer.

## SUITA PA Viewer Software

The SUITA PA Viewer is a software installed in PC available to remotely control the power analyzer connected via a communication interface (network port or USB port), and display the results analyzed by the power analyzer in the form of numeric, waveform, trend, vector, and bar graph.

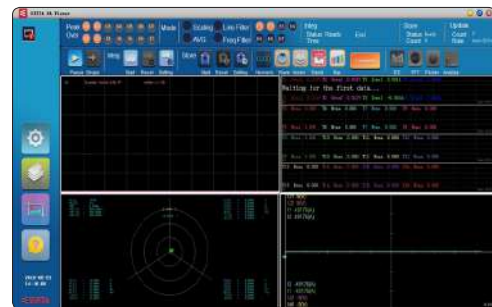

# Product Overview



- 1 Status Display I
- 2 Data Display
- 3 Indicators II
- 4 Range Setting
- 5 Other Function Settings
- 6 Navigation Keys
- 7 Integration Setup Keys
- 8 Setup, Utility, Harmonic Keys
- 9 Functions Selection
- 10 Power Key

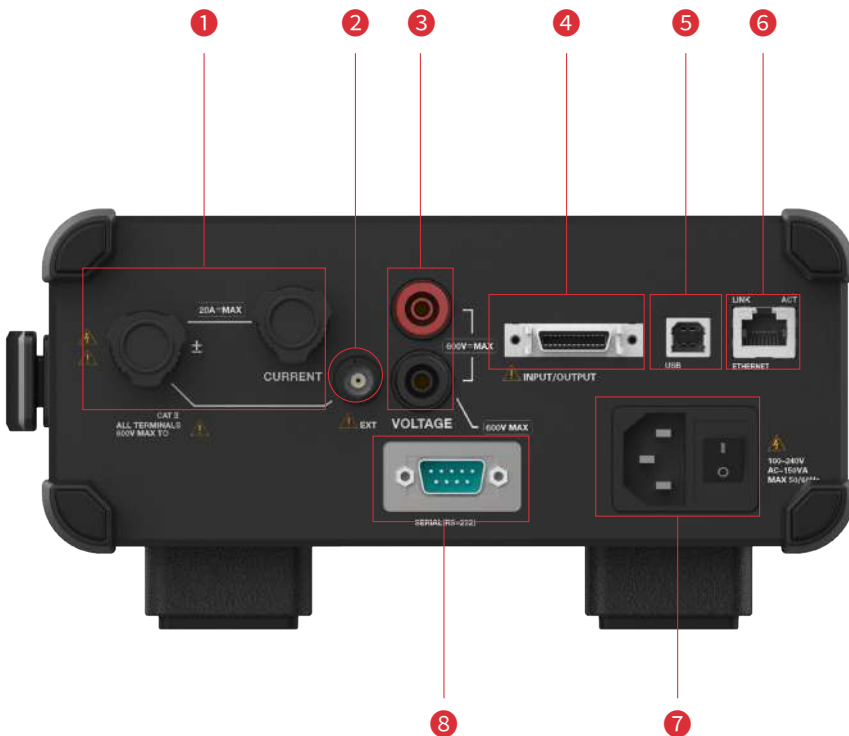

- 1 Current Input Terminal
- 2 EXT Current Sensor Input Terminal
- 3 Voltage Input Terminal
- 4 External Input(DA Port)
- 5 Type B USB Port
- 6 Ethernet Port
- 7 Power Switch and Power Cord Connector
- 8 GP-IB/RS232 connector

# Applications

This power analyzer is easy to use, economy and accurate in measurement, widely used in Production, Testing, Evaluation and Research & Development.

## Home appliances and Office equipment

Recently, there are more concerns about energy efficiency, such as reducing the power consumption for the civil electrical appliances (such as air conditioner, washing machine, induction cooker, water heater). The power analyzer can be used to test the power produced by home appliances. One piece of the power analyzers of this series can effectively measure the voltage, current, power, frequency, power factor and THD (Harmonic distortion).



## Industrial equipment and Transportation

### Automotive - Battery or Driven Device Evaluation

This power analyzer can directly measure the high current up to 50A. This provides an economical and accurate method for testing DC driven devices in vehicles without any extra sensors.

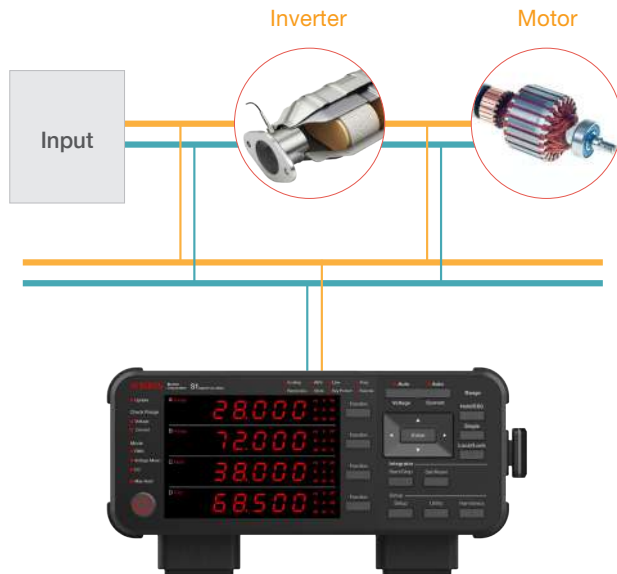

### Testing in Production Line

This instrument is so compact in structure to be easily mounted on the shelf for testing during production. Testing platform can be economically set up at a favorable price.

The parameters such as voltage, current, frequency, power factor, and harmonics can be measured by this power analyzer, so as to improve testing efficiency.

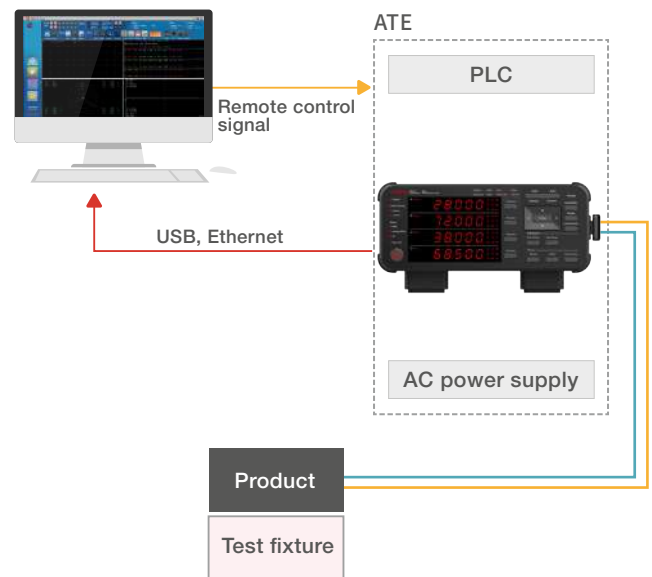

### Evaluation Testing of Special Waveform Driven Devices and Distorted Waveforms (including DC Component)

The power analyzer of this series has a broad frequency capability of DC (from 0.1Hz to 100 kHz). It can measure the RMS value of distorted waveforms like square waveforms or special waveform driven devices. The average active power measurement function gives accurate power consumption data for fluctuating power devices such as burst waveform operated devices. Therefore the users can perform accurate distorted waveform measurements without any need to setting special modes.

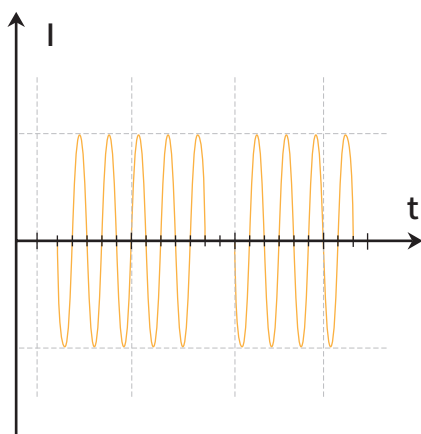

Inter-harmonics

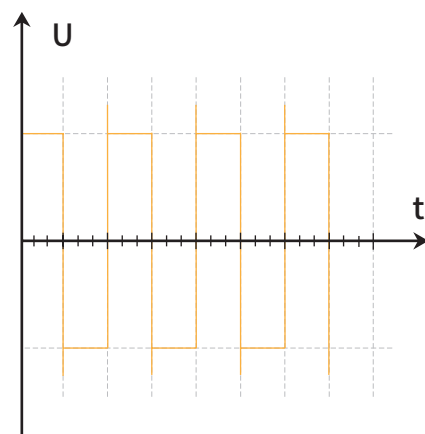

Square Wave



# Technical Specifications

## Input

Item	Specification		
Input terminal type	<b>Voltage:</b> Plug-in terminal(safety terminal) <b>Current:</b> Direct input: binding post External current sensor input option: Isolated BNC connector		
Input format	<b>Voltage:</b> Floating input through resistive voltage divider <b>Current:</b> Floating input through shunt		
Measurement range	Voltage	<b>CF3:</b> 6V/10V/15V/30V/60V/100V/150V/300V/600V <b>CF6/6A:</b> 3V/5V/7.5V/15V/30V/50V/75V/150V/300V	
	Current Direct input	<b>Type 1</b> CF3:5mA/10mA/20mA/50mA/100mA/200mA/500mA/1A/2A/5A/10A/20A CF6/6A:2.5mA/5mA/10mA/25mA/50mA/100mA/250mA/500mA/1A/2.5A/5A/10A <b>Type 2</b> CF3: 1A/2A/5A/10A/20A/50A CF6/6A: 500mA/1A/2.5A/5A/10A/25A	
	External current sensor input	<b>EX1 (High range)</b> CF3: 2.5V/5V/10V CF6/6A: 1.25V/2.5V/5V	
		<b>EX2 (Low range)</b> CF3: 50mV/100mV/200mV/500mV/1V/2V CF6/6A: 25mV/50mV/100mV/250mV/500mV/1V	
Instrument loss	Voltage	<b>Input resistance:</b> 2MΩ <b>Input capacitance:</b> 13pF	
	Current	Direct input	<b>Type 1:</b> <b>When 5mA~20mA:</b> Input resistance: 5Ω Input inductance: Approximately 0.1μH(resistance in series) <b>When 50mA~200mA:</b> Input resistance: 500mΩ Input inductance: Approximately 0.1μH(resistance in series) <b>When 500mA~2A:</b> Input resistance: 50mΩ Input inductance: Approximately 0.1μH(resistance in series) <b>When 5A~20A:</b> Input resistance: 5mΩ Input inductance: Approximately 0.1μH(resistance in series)

Instrument loss	Current	Direct input	<b>Type 2:</b> <b>When 1A to 5A:</b> Input resistance: 10 mΩ Input inductance: Approximately 0.1μH(resistance in series) <b>When 10A to 50A:</b> Input resistance: 1 mΩ Input inductance: Approximately 0.1μH(resistance in series)
	Direct input	Sensor Input	<b>EX1:</b> Input resistance: Approximately 100 kΩ <b>EX2:</b> Input resistance: Approximately 10 kΩ
Continuous maximum allowable input	Voltage	Peak value of 1.5kV or RMS value of 1kV, whichever is less	
	Current	Direct input	<b>Type1:</b> <b>When 5mA~200mA:</b> with 1.4A continuous overload protection <b>When 0.5A~20A:</b> with 14A continuous overload protection <b>Type 2:</b> with 140A continuous overload protection
External current sensor input		Peak value less than or equal to 5 times of the rated range.	
A/D converter	Simultaneous conversion of voltage and current inputs. <b>Resolution:</b> 16-bit <b>Maximum conversion rate:</b> 10us		
Range selection	manual or auto		
Auto range	Range up (The range is increased when any of the following conditions is met.)	<ul style="list-style-type: none"> <li>Urms or Irms exceeds 110% of the range selected 110%.(When in crest factor 6A, greater than 220%.)</li> <li>When in crest factor 3: Upk or lpk of the input signal exceeds 330% of the range selected.</li> <li>When in crest factor 6 or 6A: Upk or lpk of the input signal exceeds 660% of the range selected.</li> </ul>	
	Range down (The range is decreased when all of the following conditions are met.)	<ul style="list-style-type: none"> <li>Urms or Irms is less or equal to 30% of the measurement range.</li> <li>When in crest factor 3: Upk and lpk of the input signal are less than 300% of the next lower measurement range.</li> <li>When in crest factor 6 or 6A: Upk and lpk of the input signal are less than 600% of the next lower measurement range.</li> </ul>	



## Measurement Accuracy

Conditions: Temperature: 23±5°C; Humidity: 30 to 75%RH; Input waveform: Sine wave; Crest factor: 3; Common-mode voltage: 0V; Scaling function: OFF; Number of displayed digits: 5 digits; Frequency filter: Turn ON to measure voltage or current of 200 Hz or less; After 30 minutes of warm-up time has passed; Zero setting before wiring; Frequency f with unit kHz; within half a year after calibrated.

Format: ± (% of reading + % of range)

Frequency range	Voltage	Current	Active Power
DC	0.1+0.05	0.1+0.05	0.1+0.05
0.1Hz<f<45Hz	0.1+0.2	0.1+0.2	0.3+0.2
45Hz≤f≤66Hz	0.1+0.05	0.1+0.05	0.1+0.05
66Hz<f≤1kHz	0.1+0.2	0.1+0.2	0.2+0.2
1kHz<f≤10kHz	0.07*f+0.3	0.07*f+0.3	0.09*f+0.3
10kHz<f≤100kHz	0.05*f+0.5	0.05*f+0.5	0.08*f+0.5

## Measurement Conditions

Item	Specification
Crest factor	3 or 6 or 6A
Measurement period	Interval for determining the measurement function and performing calculations The measurement period is set by the zero crossing of the reference signal (When synchronization source is set to be None, measurement period becomes data update interval.)
Measurement mode	Select RMS(the true RMS value of voltage and current), DC (simple average of voltage and current), MEAN (The rectified mean value calibrated to the RMS value of the voltage)
Measurement synchronization	Select voltage, current or None
Scaling	Set the current sensor transformation ratio, VT ratio, CT ratio, and power factor when applying the external current sensor, VT, or CT output to the instrument. Selectable range: 0.001 to 9999
Line Filter	Select OFF, 100Hz, 500Hz, or 1KHz
Frequency Filter	Select OFF or ON(cutoff frequency of 500Hz)
Averaging	Exponential average: Select an attenuation constant from the values of 8, 16, 32, and 64. Linear average: Select the number of averages from the values of 8, 16, 32, and 64. Harmonic measurement: Only exponential averaging is available.
Data update interval	Select 50ms, 100ms, 200ms, 500ms, 1s, 2s, 5s, 10s, 20s or Auto
Peak measurement	Measure the peak (max/min) value of voltage, current or power from the instantaneous voltage, instantaneous current or instantaneous power that is sampled.
Max hold	ON or OFF

Zero-level compensation	Remove the internal offset of this power analyzer.
-------------------------	--

## Display

Item	Specification
Display Type	7-segment LED
Displayed Items	Simultaneously display 4 items
Unit Symbols	m, k, M, V, A, W, VA, var, °, Hz, h±, TIME, %
Response Time	At maximum, 2 times the data update rate The time it takes to reach the accuracy of the final value when the displayed value changed from 0 to 100% or 100 to 0% of the rated range.
Hold	Hold the displayed value
Single update	Update the displayed value once each time the SINGLE key is pressed during Hold.

## Frequency Measurement Function

Item	Specification	
Measured source	Voltage and current frequencies applied to one selected input element can be measured.	
Frequency measuring range	Data Update Interval	Measurement Range
	50ms	45Hz≤f≤100kHz
	0.1s	25Hz≤f≤100kHz
	0.2s	12.5Hz≤f≤100kHz
	0.5s	5Hz≤f≤100kHz
	1s	2Hz≤f≤100kHz
	2s	1Hz≤f≤100kHz
	5s	0.5Hz≤f≤100kHz
	10s	0.2Hz≤f≤100kHz
	20s	0.1Hz≤f≤100kHz
Auto	0.1Hz≤f≤100kHz	
Frequency accuracy	<b>Requirements:</b> When the input signal level is 30% or more of the measurement range. (60% or more if the crest factor is set to 6 or 6A) · Frequency filter is ON when measuring voltage or current of 200Hz or less. <b>Accuracy:</b> ±(0.06% of reading)	
Minimum frequency resolution	0.0001Hz	

## Integration

Item	Specification
Mode	Manual, Normal, Continuous(Repeat)
Timer	Automatically stop integration by setting a timer. <b>Selectable range:</b> 00:00:00 ~ 10000:0:0 (0 Hour 00Minute 00Second: Manual mode for integration)



Count over	<ul style="list-style-type: none"> <li>If the integration time reaches the maximum integration time,</li> <li>If the integration value reaches maximum/minimum display integration value</li> </ul>
Accuracy	<p><b>Fix range:</b> <math>\pm</math>(Power accuracy (or current accuracy)+0.1% of reading)(fixed range)  <b>Auto range:</b> The measurement will not be performed during range change  The first measured value will be added after range changed and during the period when measurement is not performed.</p>
Timer accuracy	$\pm 0.02\%$

## Harmonic Measurement

Item	Specification			
Frequency Range	Fundamental frequency of the PLL source is in the range of 10 Hz to 1.2 kHz <b>PLL source:</b> voltage and current of each input element			
FFT Data Length	1024			
Sample rate, window width, and upper limit of harmonic analysis	Fundamental Frequency	Sample Rate	Window Width	Upper Limit of Harmonic Analysis
	10Hz ~ 75Hz	$f^*1024$	1	100
	75Hz ~ 150Hz	$f^*512$	2	32
	150Hz ~ 300Hz	$f^*256$	4	16
	300Hz ~ 600Hz	$f^*128$	8	8
	600Hz ~ 1.2kHz	$f^*64$	16	4
Accuracy: $\pm$ (...% of reading+ ...% of range)	Add the following accuracy to the accuracy at normal measurement. When the line filter is off:			
	Frequency	Voltage	Current	Active Power
	10Hz $\leq$ f <45Hz	0.15+0.1	0.15+0.1	0.35+0.2
	45Hz $\leq$ f $\leq$ 440Hz	0.15+0.1	0.15+0.1	0.25+0.2
	440Hz <f $\leq$ 1kHz	0.2+0.1	0.2+0.1	0.3+0.2
1kHz <f $\leq$ 1.2kHz	0.5+0.3	0.5+0.3	1.4+0.3	

## D/A Output

Item	Specification
Output Voltage	5V full scale(approximately $\pm 7.5V$ maximum) against each rated values.
Number of Output Channels	4 outputs

Output Items	U, I, P, S, Q, $\lambda$ , $\emptyset$ , fu, fl, Upk, Ipk, WP, WP $\pm$ , q, q $\pm$ , MATH
Accuracy	$\pm$ (accuracy of each measurement item+0.2% of full scale)(FS=5V)
Minimum load	100k $\Omega$
Update Interval	Same as the data update interval; When update interval is set to AUTO, data update interval equals to signal period(more than 100ms).
Temperature coefficient	$\pm 0.05\%/^{\circ}C$ of full scale
D/A conversion resolution	16bit
Input signal in remote control	EXT HOLD, EXT TRIG, EXT START, EXT STOP, EXT RESET
Output signal in remote control	INTEG BUSY
Input/Output level	TTL
Input/Output logic format	Negative logic, falling edge

## Hardware Interface

Item	Specification
External Clock Input	BNC connector; TTL level; Square waveform with a duty ratio of 50%.
D/A Terminal	$\pm 5V$ ; approximately $\pm 7.5V$ (maximum); TTL level

## Communication Interfaces

Items	Specifications
Type B USB Interface	Conforms to the USB Rev.2.0; USBTMC-USB488(USB Test and Measurement Class Ver.1.0)
Ethernet Interface	RJ-45 connector; Conforms to IEEE802.3; 100BASE-TX, 10BASE-T
GP-IB Interface	Conforms to IEEE Standard 488-1978 (JIS C 1901-1987); Conforms to the IEEE Standard 488.2-1992
RS-232 Interface	9-pin, D-Sub (plug); Conforms to EIA-574, standard of 9-pin EIA-232(RS-232)

## General Specification

Items	Specifications
External dimensions	227.5mm*370.0mm*112.8mm
Rated supply voltage	From 100 to 240 VAC
Permitted supply range voltage	From 90 to 264 VAC
Rated supply frequency	50/60Hz
Permitted supply voltage frequency range	From 48 to 63 Hz
Max. power consumption	20VA
Warm-up time	Approximately 30 minutes
Operation environment	<b>Temperature:</b> 5°C ~ 40°C <b>Humidity:</b> from 20% to 80%RH(no condensation)
Operating altitude	2000m or less
Applicable environment	Indoors
Storage environment	<b>Temperature:</b> -25°C ~ 60°C <b>Humidity:</b> from 20% to 80%RH(no condensation)
Weight	Approximately 4kg
Battery backup	Setup parameters are backed up with a lithium battery.

## Measurement Conditions

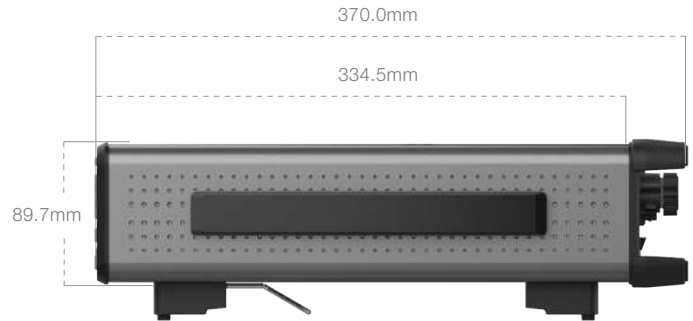

# Accessories

## Current Sensor of SHT Series

Item \ Model	SHT60	SHT200	SHT600	SHT1000
DC	0-60A	0-200A	0-600A	0-1000A
AC	60Apeak	200Apeak	600Apeak	1000Apeak
Accuracy	±(0.05% of rdg + 15µA)	±(0.05% of rdg + 15µA)	±(0.05% of rdg + 15µA)	±(0.05% of rdg + 15µA)
Measuring bandwidth	DC-500KHz	DC-300KHz	DC-200KHz	DC-150KHz
Ratio K <sub>v</sub>	1: 600	1: 1000	1: 1500	1: 2000
Resistance R <sub>m</sub>	0--25Ω	0--25Ω	0--12Ω	0 -- 4Ω
Aperture	Ø28mm	Ø28mm	Ø30.9mm	Ø30.9mm
Connector	DB9	DB9	DB9	DB9
Supply	±12V~±15V	±12V~±15V	±15V~±24V	±15V~±24V

## Boxes

Name	Single-phase Junction Box
Model	PG01A
Sample	
Usage	It is used for single phase circuit connection to measure power parameters conveniently via power analyzer

## Connectors and Cables

Name	Model	Sample	Specification
Fork terminal adapter	PAC-1001		Used when attaching banana plug to binding post. <b>Specification:</b> 1000V, 20A <b>Color:</b> red, black
BNC Conversion adapter	PAC-1002		<b>Connector:</b> Conversion between safety BNC and banana plug <b>Specification:</b> Ø4mm , 1000V, 1A
Safety adapter	PAC-1003		<b>Connector:</b> Safety adapter; Screw can be used for tightening the test cables. <b>Specification:</b> Ø4mm , 1000V, 20A <b>Color:</b> red, black
Safety adapter	PAC-1004		<b>Connector:</b> safety adapter, spring-hold type <b>Specification:</b> Ø4mm, 600V, 10A <b>Color:</b> red, black
Safety clamp	PAC-1005		<b>Connector:</b> hook shape <b>Specification:</b> 1000V <b>Color:</b> red, black

Large alligator adapter	PAC-1006		Connector: safety adapter Specification: Ø4mm , 1000V Color: red, black
Small alligator adapter	PAC-1007		Connector: safety adapter Specification: Ø4mm ,300V Color: red, black
Measurement lead	PAL-1001		Connector: safety connector Specification: Ø4mm , 1m, 600V, 32A Color: red, black
Safety BNC cable	PAL-1002		Connector: BNC plug Specification: 1m Color: black

## Case

Sample	Model	Size
	PY01A	456.7mm*565.0mm*290.0mm

## Models and Codes

Name	Model	Descriptions
Instrument	S1	Power analyzer
Input Module	S1-20A105	20A,600V, 0.1%+0.05%
	S1-50A105	50A,600V, 0.1%+0.05%
Function Module (Option)	/DA4	D/A output
	/CE	Ethernet
	/CU	USB
	/CR	RS232 ( or GPIB )
	/CG	GP-IB ( or RS232 )
	/EX1	External current sensor 2.5V-10V ( or /EX2 )
	/EX2	External current sensor 50mV-2V ( or /EX1 )
Accessory mounted on the support	/HA	Harmonic measurement
	PAA1004	Used when the instrument mounted on the support
	PAA2004	Used when the instrument mounted on the support(two instruments)

\* Product specifications and models are subject to change without notice.